

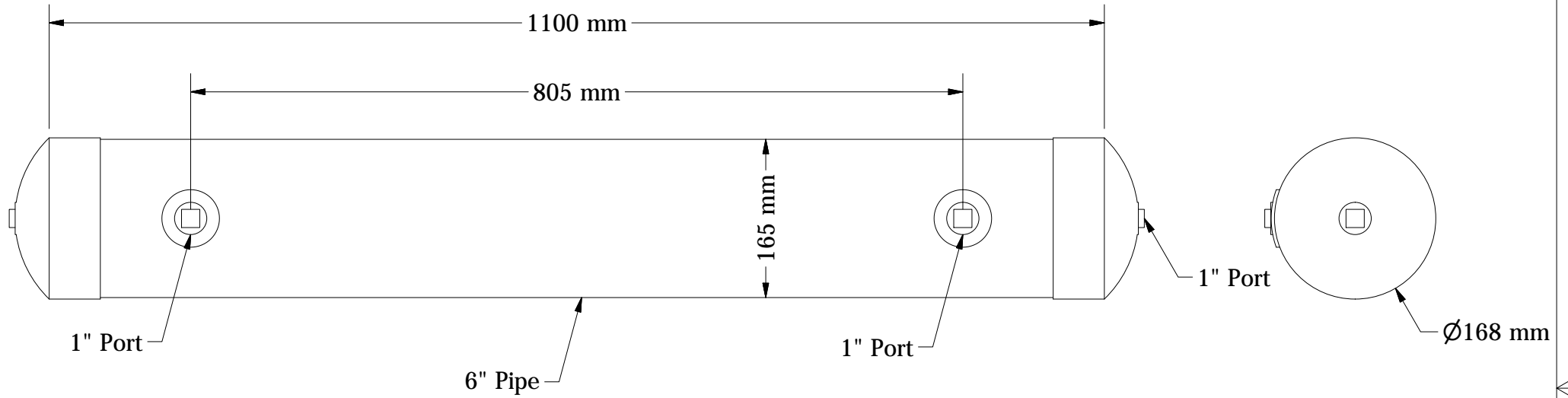

UF S-640
SCALE 1 : 8



Specification

Capacity : 1500-1800 L/hour
 Material : PVC
 Weight : +/- 12 kg

DRAWN Andree	02/04/2011
CHECKED	
APPROVED	

			
TITLE			
UF S-640			
SIZE	DWG NO	REV	
A4	GDP-UF-S-640		
SCALE	SHEET 1 OF 5		

